

ATmega328P

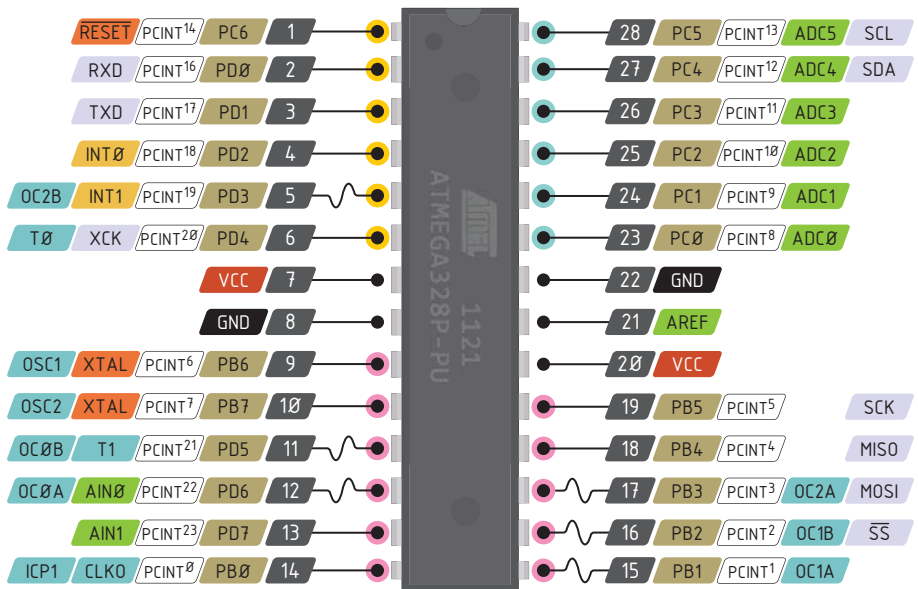







Pinout

 **Absolute** MAX per pin
40mA, 20mA recommended



 **Absolute** MAX per pin 200mA
for the entire package

 The total current of each port
power group **should not exceed** 100mA

-  Power
-  GND
-  Physical PIN
-  Port PIN
-  Analog PIN
-  Serial PIN
-  PIN Function
-  Interrupt PIN
-  Control PIN

 PWM Pin

 Port power group

