



















MINI PINOUT

 The power sum for each pin's group should not exceed 100mA

-  IDE
-  Power
-  GND
-  Serial Pin
-  Analog Pin
-  Control
-  INT
-  Physical Pin
-  Port Pin
-  Pin function
-  Interrupt Pin
-  PWM Pin
-  Port Power 

-  0
-  1
-  7

-  1
-  0

-  2
-  3
-  4
-  5
-  6
-  7
-  8
-  9

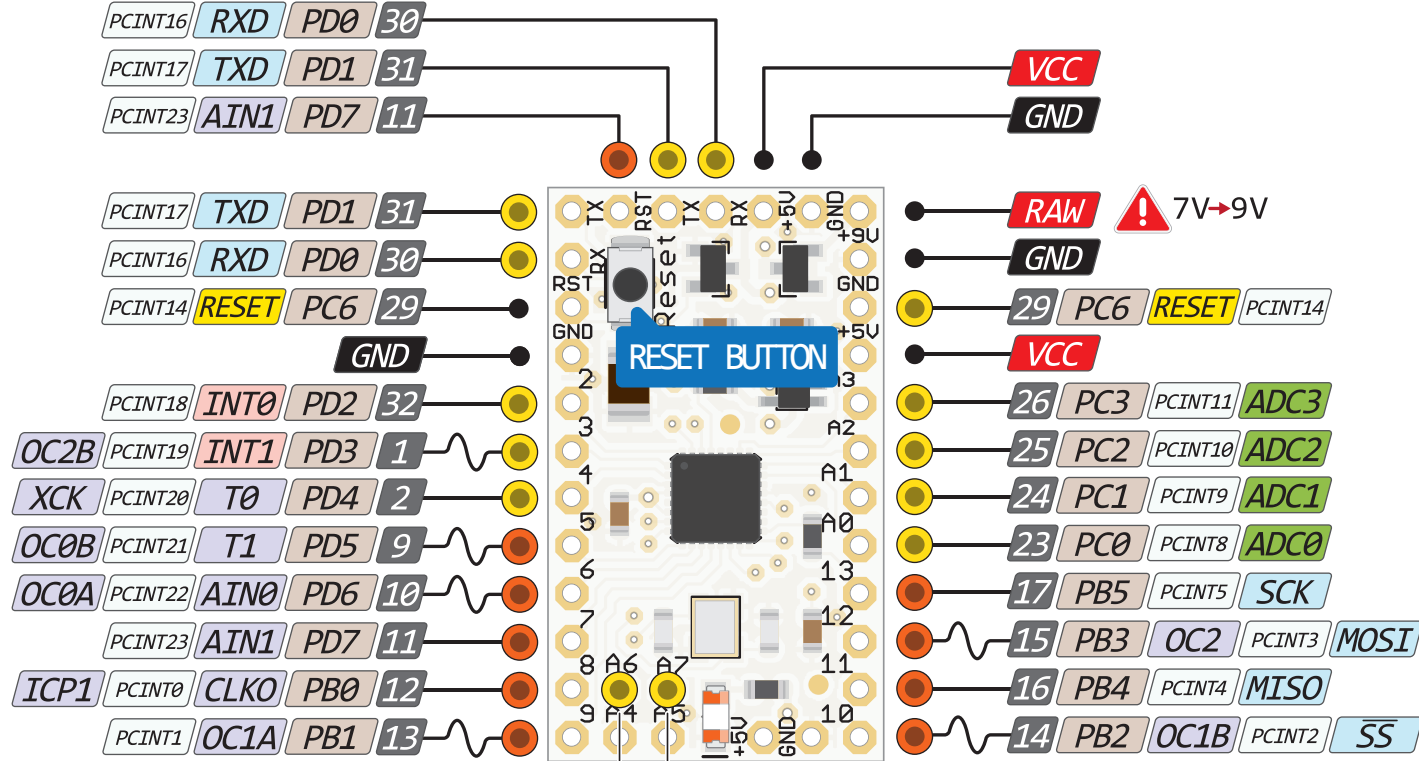

-  17A3
-  16A2
-  15A1
-  14A0
-  13
-  12
-  11
-  10

 Absolute MAX per pin 40mA
recommended 20mA

 Absolute MAX 200mA
for entire package

 Absolute MAX 150mA
when RAW powered

 Analog exclusively Pins

-  19A5
-  18A4
-  A7
-  A6